

Aputure[®]

Light  storm

LS 1
Product Manual

English

Foreword

Thank you for purchasing the Light Storm LS 1

The Light Storm LS 1 includes LS 1s and LS 1c. It is made of 1536 lamp beads which are designed and manufactured carefully to have over 95 CRI value. Delicate design and elaborating production make a robust but exquisite housing, which can fulfill low forward heat of the fixture. LS 1 offers dual power solutions. You can use V-Mount or Anton Bauer battery in a location shooting. Besides, adapter attached is for your indoor shooting. LS 1 is with the ability to adjust the brightness and the color temperature (LS 1c). Two antennas can cover all the surrounding within 360°. You can also control the brightness and color temperature of LS 1 by a DMX console which is under the standard DMX512 protocol. Light Storm, the best choice for your shooting.

Instructions

- **Please read this product manual carefully.**
- Keep this product manual. Always includes this product manual when passing the products on to the third parties.
- Heed all warnings and follow all instructions in this product manual as stated.
- Please do not disassemble or modify the Light Storm LS 1, or it could result in electric shock or product malfunction.
- Please do not handle with wet hands or immerse in or expose to water or rain, or it could result in fire or electric shock.
- Please do not use the Light Storm LS 1 in the presence of flammable gas, or it could result in explosion.
- Please keep all liquids and flammable gas away from the Light Storm.
- Keep away from strong sunlight or other high temperature, or it may explode.
- Please do not damage, disassemble, drag or wind power cable. Do not place heavy things on the Light Storm, or it may cause fire or electric shock.
- Please clean the Light Storm LS 1 with a dry cloth.
- Use of original Aputure cable accessories is recommended. Please note that this warranty does not apply to repairs arising out of the malfunction of non-original Aputure accessories, although you may request such repairs on a chargeable basis.
- The product is certificated by ROSH, CE and FCC. Please operate the product in full compliance with the operation standards. Please note that this warranty does not apply to repairs arising from malfunction, although you may request such repairs on a chargeable basis.
- The instructions and information in this manual are based on thorough, controlled company testing procedures. Further notice will not be given if the design or specifications change.

Intended use

Intended use of the Light Storm LS 1 means:

- The user has read the instructions of this manual.
- The user is using the products within the operating conditions and limitations described in this product manual.
- "Improper use" means using the products other than as described in these instructions or under operating conditions which differ from those described herein.

Item check list

Before starting, please check that all the following items have been included with the Light Storm LS 1. If anything is missing, contact your dealer immediately.

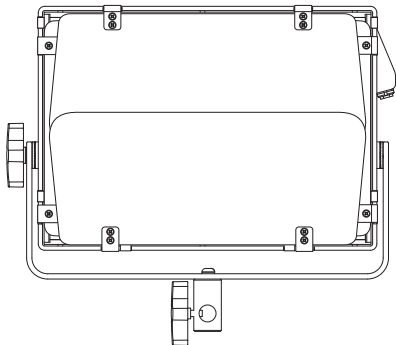

Light

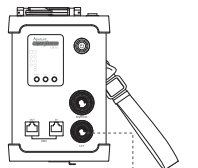

Controller box

(*Color temperature wheel only for LS 1c)

Buckle



Hook



Button battery



Controller



AC/DC adapter



Clamp (5 PCS)



Warranty



Product manual



Power cable



Tracing papers (10 PCS)



Magic strip

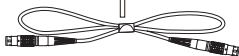

Connect cable

Nomenclature

1. Light

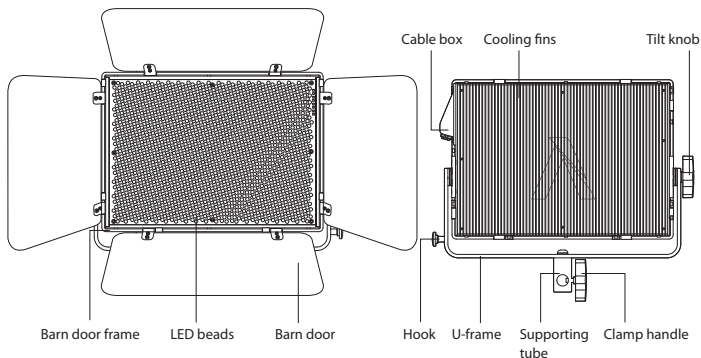

2. Controller box

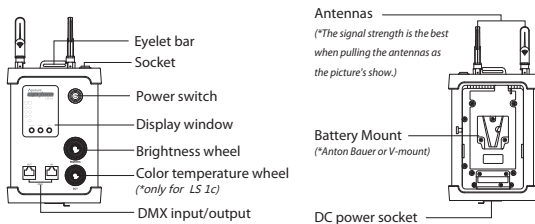

3. Controller

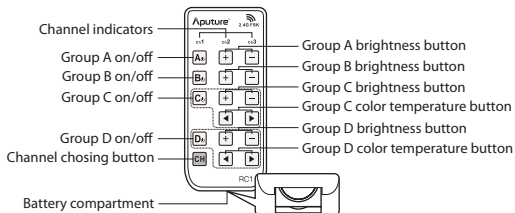

4. Display window

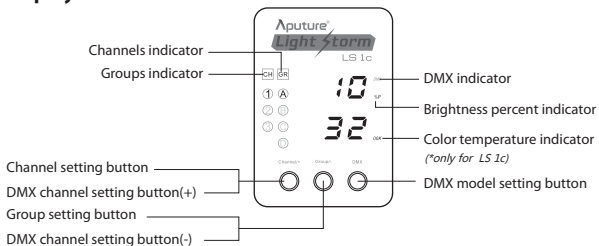

Installations

1. Install the hook

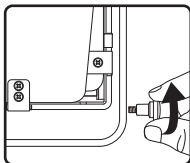

2. Install the light

- 1) Turn around the clamp handle to install the light on the tripod.

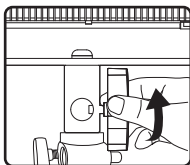

- 2) Set the light at a specific angle, and pull or turn around the tilt knob to fasten the light.

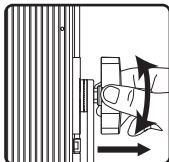
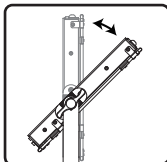

3. Insert the connect cable dot to dot to power the light .

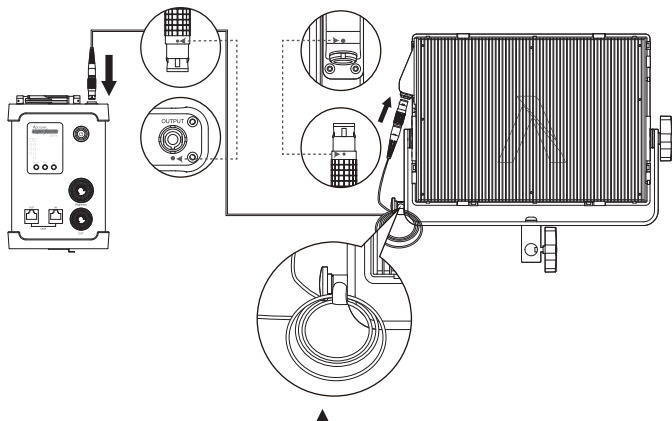

**Tie the connect cable around the hook*

4. Power the controller box

1) Powered by the adapter

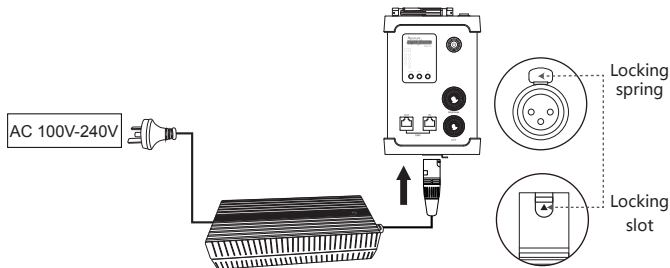

** Please pull the power adapter out by pushing the locking spring down on the controller box.*

2) Powered by the battery

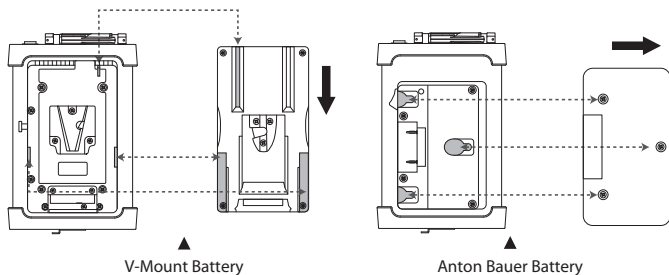

* Battery output current $\geq 8A$;

* Please choose the model of the Light Storm by your battery need.

5. Clip the tracing paper by the clamps

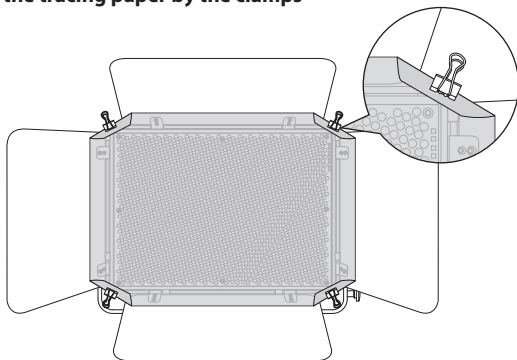

6. Insert the button battery to power the controller.

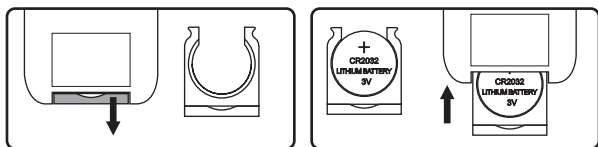

Operations

1. Press power switch to turn on the Light Storm LS 1.

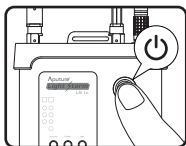

***Channel 1, Group A** is by default.*

**The brightness is 10% and the color temperature is 3200K(LS 1c) by default.*

2. Manual controlled by the controller box

1) Brightness adjustment and display

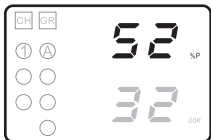
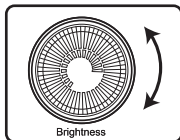

2) Color temperature adjustment and display

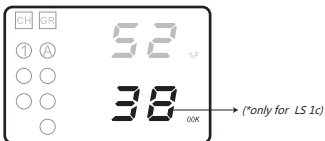
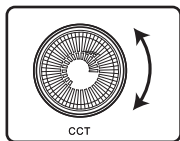

3. Remote controlled by the controller

You can control the LS 1 of channel 2, group C according to the following directions.

1) The controller box setting

*1) Channel setting and display

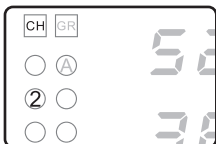
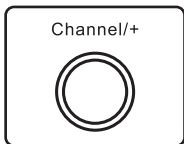

*2) Group setting and display

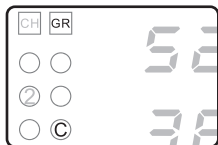
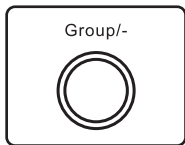

2) The controller setting and display

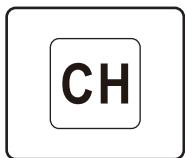

Press (**CH**) to set the channel 2

" ch2 " indicator lights

The controller setting is finished.

**The Light Storm has three channels (1/2/3) and four groups (A、 B、 C、 D).*

3) Brightness and color temperature adjustment

Press (**+** or **-**) of group C to adjust the brightness and (**◀** or **▶**) of group C to adjust the color temperature. The brightness varies in 1%, and the color temperature varies in 100k at one press. Brightness changes between 10 and 100; Color temperature changes between 32 and 55 (only for LS 1c).

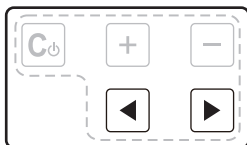
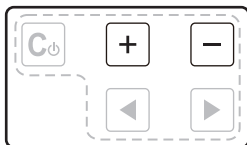

→(*only for LS 1c)

4.The DMX control

1) Connect a standard DMX console

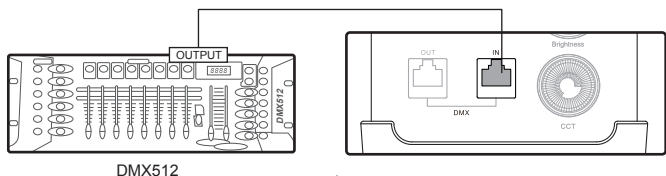

▲
Only one Light Storm

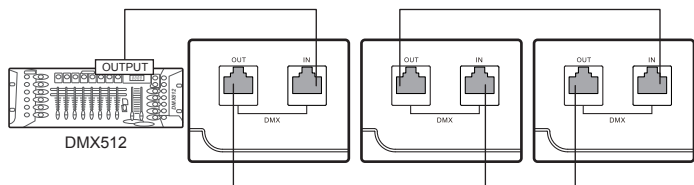

▲
One by one

* See the interface definition of the DMX as the picture shows:

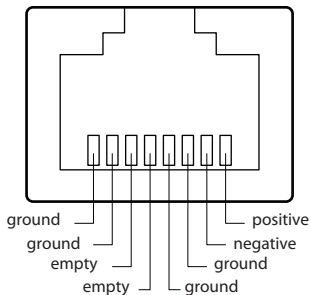

2) The DMX setting

*1) Press DMX model setting button on the controller box to enter into the DMX model.

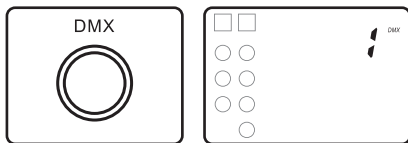

*2) Press the DMX channel setting button (+/-) on the controller box to your needed DMX channel.

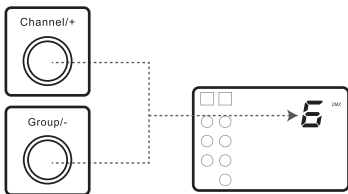

3) The standard DMX console control

Control the Light Storm by the standard console within the same DMX channel setting as above.

** Channel 1 is by default when in DMX model.*

** DMX channel is between 1 and 512, but is between 1 and 511 for the Light Storm LS 1c.*

Tips and trouble setting

- Please turn off the Light Storm LS 1 before removing batteries.
- Please do not look at the Light Storm LS 1 straightly, or it could damage your eyes.
- Please do not keep touching the Light Storm LS 1 over 5 minutes during lighting, or it could make you injured.
- Keep a distance of over 10 meters away from the Light Storm LS 1.
- Suggest to take out of the button battery of the controller if do not use the controller for a long period .

Specifications

Model		LS 1c	LS 1s
Operation Current		8A	8A
Power Supply		DC 15V	DC 15V
Power Input		120W	120W
Beam Angle		45°	25°
Color Temperature		3200K-5500K	5500K
Average Life Span		≥100,000 hours	
Cooling Mode		Natural convection heat transfer	
Radio Frequency		2.4GHz	
Channels		1/2/3	
Groups		A/B/C/D	
Remote Range		≤100m	
Sizes (L*W*H)	Light	377.8*320.7*33.2 mm	
	Controller box Anton Bauer Battery	238.0*118.7*48.1 mm <i>(*vertical antennas included)</i>	
	Controller box (V-Mount)	238.0*118.7*59.6 mm <i>(*vertical antennas included)</i>	

Brightness (average)

Model	Distance	Footcandles	LUX
LS 1c	0.5m	2323	25000
	1m	697	7500
LS 1s	0.5m	2788	30000
	1m	929	10000