

Aputure®

Light  storm

LS C120t

Product Manual

English

Foreword

Thank you for purchasing Aputure “Light Storm” LS C120t

LS C120t LED video light is the first COB design of Aputure Light Storm. It features CRI 97 and active fan cooling system with real time feedback of temperature circuit. With Ultra silent Fan, dual power supply. Standard industrial mount (Bowens mount) design offers you different lighting control requirements. Easily done for your broadcast level photography.

Instructions

- Please read and follow these instructions and keep well this manual for further use.
- Peel off the COB light warning label before using.
- Please do not block the ventilation grille or touch the COB light directly, and do not face the light directly when the light is on.
- Do not place the LED light device near liquids, alcohol or other flammable objects, avoid light device damage.
- Keep the device out of reach of children.
- Only use a microfiber and dry cloth to clean the product.
- To reduce the risk of fire or electric shock, do not use the product near water.
- Please have the product checked by an authorized service or agent if your product has a problem. The malfunctions caused by your no allowed disassembling are not under the warranty.
- Use of original Aputure cable accessories is recommended. Please note that this warranty does not apply to repairs arising out of the malfunction of non-original Aputure accessories, although you may request such repairs on a chargeable basis.
- The product is certificated by RoHS, CE and FCC. Please operate the product in full compliance with the operation standards. Please note that this warranty does not apply to repairs arising from malfunction, although you may request such repairs on a chargeable basis.
- The instructions and information in this manual are based on thorough, controlled company testing procedures. Further notice will not be given if the design or specifications change.

FCC Compliance Statement

This device complies with Part 15 of the FCC Rules. Operation is subject to the following two conditions: (1) This device may not cause harmful interference, and(2) This device must accept any interference received, including interference that may cause undesired operation.

Warning: Changes or modifications not expressly approved by the party responsible for compliance could void the user's authority to operate the equipment.

NOTE: This equipment has been tested and found to comply with the limits for a Class B digital device, pursuant to Part 15 of the FCC Rules. These limits are designed to provide reasonable protection against harmful interference in a residential installation. This equipment generates uses and can radiate radio frequency energy and, if not installed and used in accordance with the instructions, may cause harmful interference to radio communications. However, there is no guarantee that interference will not occur in a particular installation. If this equipment does cause harmful interference to radio or television reception, which can be determined by turning the equipment off and on, the user is encouraged to try

to correct the interference by one or more of the following measures:

- Reorient or relocate the receiving antenna.
- Increase the separation between the equipment and receiver.
- Connect the equipment into an outlet on a circuit different from that to which the receiver is connected.
- Consult the dealer or an experienced radio/TV technician for help.

RF warning statement:

The device has been evaluated to meet general RF exposure requirement. The device can be used in portable exposure condition without restriction.

Check list

Before starting, Make sure that there are no missing parts as below shows. If not, please contact with your sellers immediately.

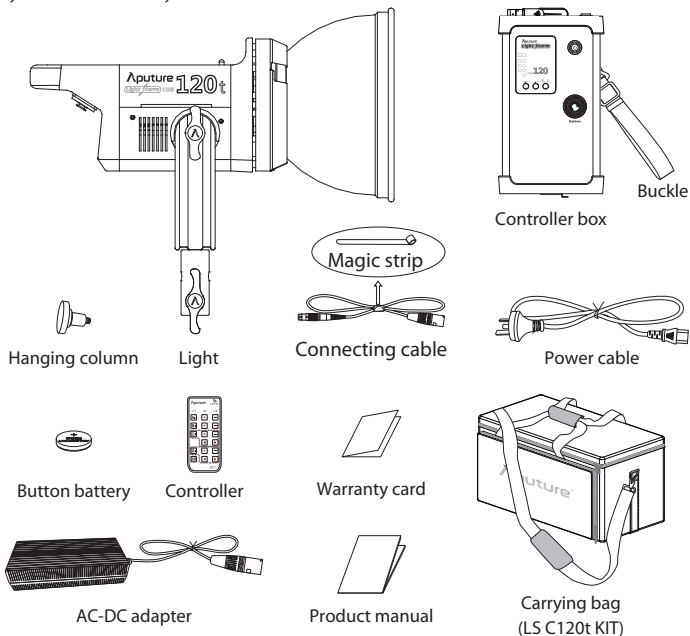

* Carrying bag is only included in LS C120t KIT, not in LS C120t.

Nomenclature

1. Light

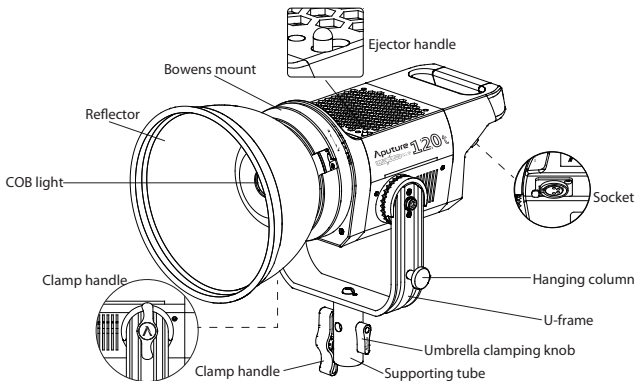

2. Controller box

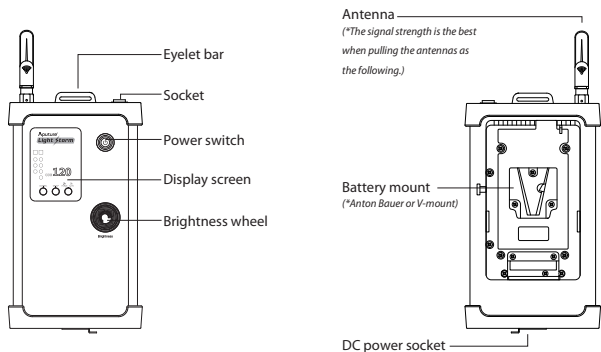

3. Controller

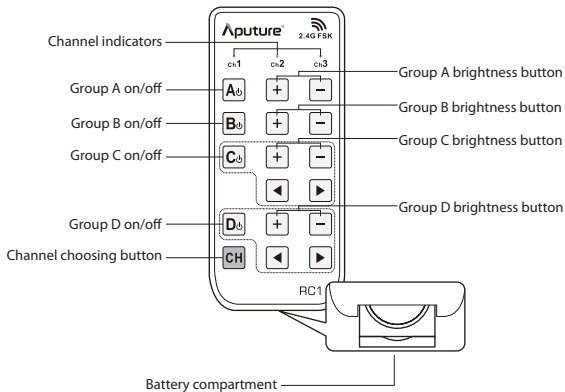

4. Display screen

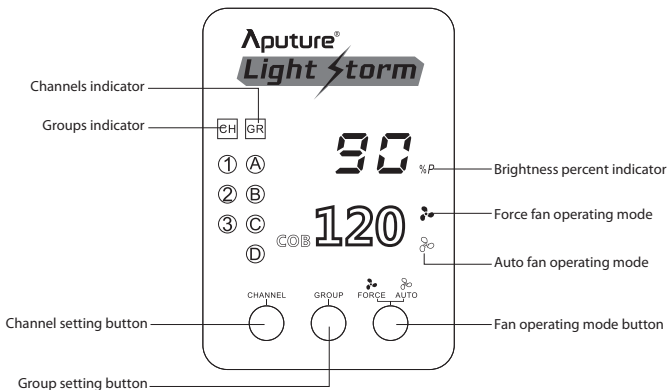

Installations

1. Install the hanging column

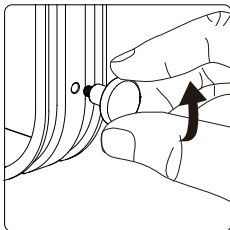

2. Install the light

1) Set the light at a specific angle, use clamp handle to install the light on the tripod.

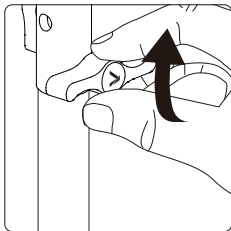
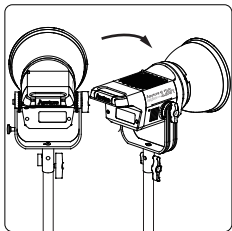

2) Set the light at a specific angle, use clamp handle to fasten the light.

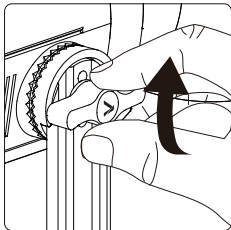
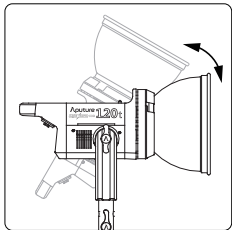

3. Use connecting cable connect light to controller box

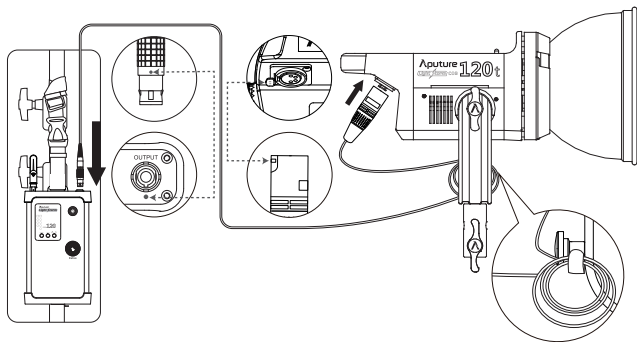

▲
** Hang the controller box on the tripod by buckle.*

▲
** Tie the connecting cable around the hanging column*

4. Dual power supply

1) Powered by the adapter

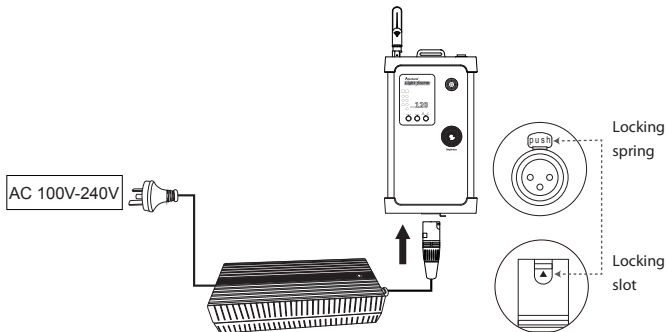

** Please pull the power adapter out by pushing the locking spring down on the controller box.*

2) Powered by the battery

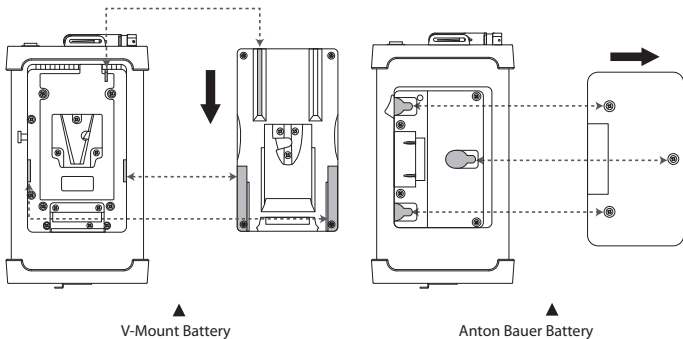

* Please buy the battery base on the model of the Light Storm you choose.

Operations

1. Press power switch to turn on the Light

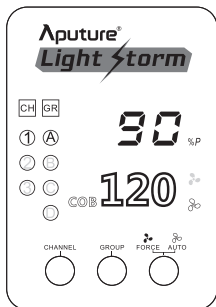
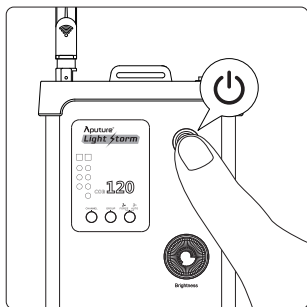

* "Channel 1 ,Group A" is by default.

2. Manual controlled by the controller box

1) Brightness adjustment and display

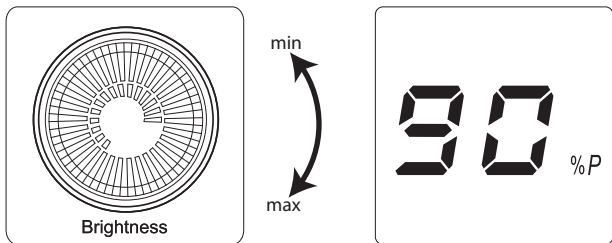

2) Press the (Auto/Force) button can adjust the fan operating model based on using environments, as the following picture shows

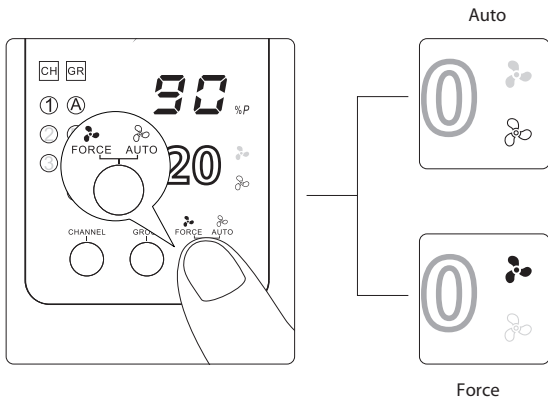

* 1) Auto Mode: According to the internal temperature of the light to automatically adjust the fan speed. ("Auto mode" is by default)

* 2) Force Mode: Fan work at the highest speed for optimal heat dissipation. (This mode is recommended in high temperature environments)

3. Remote controlled by the controller

You can control the LS C120t of channel 2, group B according to the following directions.

* The Light Storm has three channels (1/2/3) and four groups (A、B、C、D).

1) The controller box setting

*1) Channel setting and display

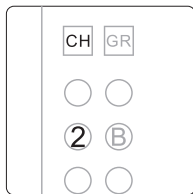
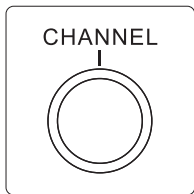

*2) Group setting and display

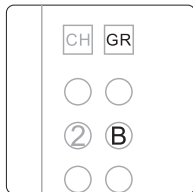
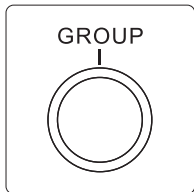

2) The controller setting and display

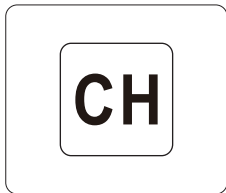

Press () to set the channel 2



"ch2" indicator lights

The controller setting is finished.

3) Brightness and color temperature adjustment

Press (\oplus \ominus) of group B to adjust the brightness, the brightness varies 1%. brightness changes between(10%-100%).

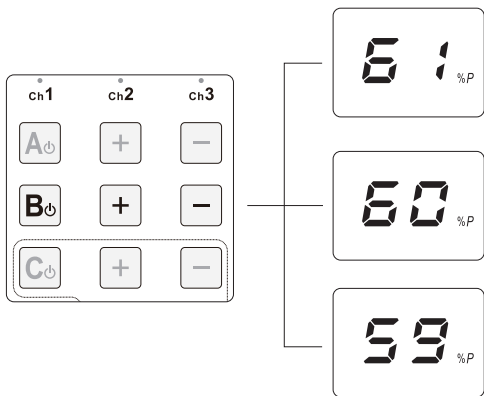

Reflector Unlock

Pull ejector handle back, and unlock reflector as the picture shows.

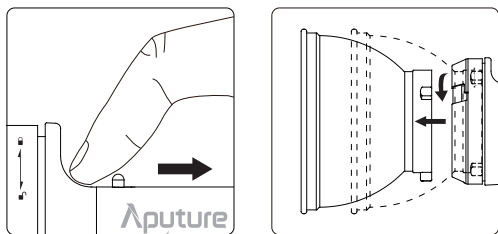

Specifications

Operation Current	9A	Power Consumption	135W maximum
Power Supply	DC 15V	Cooling Mode	Active Cooling
TLCI	≥97	CQS	≥95
CRI	≥97	Color Temperature	3000K
Radio Frequency	2.4GHz	Channels	1/2/3
Groups	A/B/C/D	Remote Ability	≤100m
Sizes (L*W*H)	Light	336.4*186.3*283.9mm	
	Controller box Anton Bauer Battery	269.0*118.7*48.1mm(*vertical antennas included)	
	Controller box (V-Mount)	269.0*118.7*59.6mm(*vertical antennas included)	

Brightness (average)

Distance	0.5m	1m	2m
Footcandles	1032	232	57
LUX	11100	2500	610

Trademarks

Bowens is a trademark or registered trademark of Bowens in the P.R.C and other countries.

Anton bauer is a trademark or registered trademark of Anton bauer in the US and other countries.