

VILTROX

DC-70 II

7" High-definition LCD Monitor



Shenzhen Jueying Technology Co.,Ltd.
2/F,Blk 4, Baokun Science and Technology Industrial Park,Xialingpai,
Dalang Str.,Longhua,Shenzhen,China
www.viltrox.com

User manual

EN



Contents

Precaution.....	1
On cleaning.....	2
Before use.....	3
Product function.....	4
Identifying the parts.....	5
Attaching the battery and adaptor.....	6
Install / Uninstall adaptor.....	7
HDMI cable connection.....	8
Sun shade hood.....	9
Adjusting the direction of the screen.....	10
Menus operation.....	11
Troubleshooting.....	16
Specifications.....	17
Available signal formats.....	18

Before using the product , please read this manual carefully.
Keep this manual safety in case you need to check during your usage.
Operate this product on base of your full understand of this manual.

Specifications subject to change without notice.For more information, please visit www.viltrox.com



Precaution

About the battery pack, AC adaptor and charger

A battery pack, AC adaptor and charger are not supplied. Use a compatible battery pack or AC adaptor (pages 9). If you do not have a battery pack or AC adaptor, purchase them separately.

Handling the LCD screen

- ⦿ Do not leave the LCD screen facing the sun as it can damage the LCD screen. Take care when you place the unit by a window.
- ⦿ Do not push or scratch the LCD monitor's screen. Do not place a heavy object on the LCD monitor's screen. This may cause the screen to lose uniformity.
- ⦿ If the unit is used in a cold place, horizontal lines or a residual image may appear on the screen. This is not a malfunction. When the monitor becomes warm, the screen returns to normal.
- ⦿ If a fixed picture such as a frame of a divided picture or time code, or a still picture is displayed for a long time, an image may remain on the screen and be superimposed as a ghosting image.
- ⦿ The screen and the cabinet become warm during operation. This is not a malfunction.
- ⦿ The LCD panel fitted to this unit is manufactured with high precision technology. Thus a very small proportion of pixels may be "stuck", either always off (black), always on (red, green, or blue), or flashing. In addition, over a long period of use, because of the physical characteristics of the liquid crystal display, such "stuck" pixels may appear spontaneously. These problems are not a malfunction.



On cleaning

1. Before cleaning be sure to remove the battery first.
2. The monitor screen surface is especially treated to reduce reflection of light. As incorrect maintenance may impair the performance of the monitor.
3. Take care wipe the screen gently with a soft cloth such as a cleaning cloth or glass cleaning cloth.
4. Stubborn stains may be removed with a soft cloth such as a cleaning cloth or glass cleaning cloth lightly dampened with water.
5. Never use solvent such as alcohol, benzene or thinner, or acid, alkaline or abrasive detergent, or chemical cleaning cloth, as they will damage the screen surface.
6. Clean the cabinet gently with a soft dry cloth. Stubborn stains may be removed with a cloth lightly dampened with mild detergent solution, followed by wiping with a soft dry cloth.
7. Use of alcohol, benzene, thinner or insecticide may damage the finish of the cabinet or remove the indications on the cabinet. Do not use these chemicals.
8. If you rub on the cabinet with a stained cloth, the cabinet may be scratched.
9. If the cabinet is in contact with a rubber or vinyl resin product for a long period of time, the finish of the cabinet may deteriorate or the coating may come off.
10. Do not dispose of this unit with ordinary garbage. Do not throw the monitor away with garbage that will be placed in a landfill.
11. The top of this unit and the ventilation holes and metal parts may become hot after long use. Be very careful if holding this unit during or after use.
12. During take-off and landing, follow the onboard instructions concerning this unit.



Before use

Read this instruction manual together with the instruction manual of your camera.

This unit is not dust-proof, splash-proof or waterproof. Regardless of whether this unit is in use or in storage, do not place it in any of the following locations. Doing so may lead to a malfunction.

- Placing this unit in locations subject to direct sunlight such as on dashboards or near a heater may cause this unit to deform or malfunction.
- Locations with excessive vibration
- Locations with strong electromagnetism
- Locations with excessive sand

In locations such as the seashore and other sandy areas or where dust clouds occur, protect the unit from sand and dust. This may lead to a malfunction.

Checking the accessories

Check that the following accessories are supplied.

1. Standard Shoe adaptor
2. Sun shade hood
3. HDMI cable
4. Carrying pouch
5. Set of printed documentation

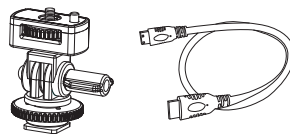
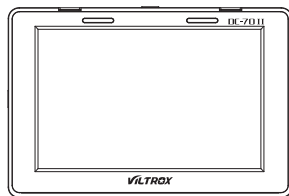

Product function

DC-70II a portable LCD monitor for use with an Interchangeable Lens Digital Camera or an Interchangeable Lens Digital HD Video Camera Recorder with an HDMI terminal and live view mode. It can display HDMI video output from the camera. The following functions help you to see the image more clearly and take better pictures.

- Wide viewing angle LCD screen
- Useful functions such as peaking and pixel-by-pixel zoom
- Controls camera shutter release, ensures the long-distance monitor.
- Moveable shoe adaptor enables easy removal when using a camera that has an auto lock accessory shoe.
- Works with rechargeable battery or power adapter.

Viltrox DC-70II Clip-on LCD Monitor adopts with 7-inch TFT high resolution LCD panel, is loaded with pro-style features to help photo enthusiasts and video-graphers shoot high-quality HD video footage with their Interchangeable Lens Digital camera. There is also pixel magnification and peaking facility which will ensure accurate focus confirming, give an enlarged pixel-perfect view of a selected portion of the Full HD image.

Viltrox DC-70II Clip-on LCD Monitor has angle adjustment shoe adaptors, they fulfill the different angles need in the real shooting process. DC-70II has two HDMI jacks and one AV jack to get the video signal from the camera; the shutter release jack succeeds to control shooting when DC-70II epitaxial the camera LCD display.



Identifying the parts

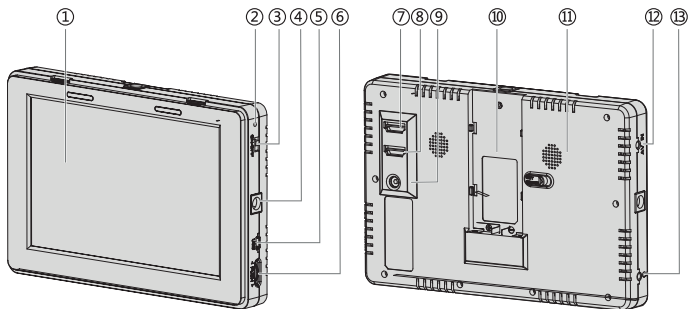

- ① LCD screen
- ② Power lamp :When the power is on, this lamp lights up or blinks depending on the status of this unit.
- ③ Power button
- ④ Tripod receptacle
- ⑤ USB jack
- ⑥ Operation dial: Brings up and operates the menu.

Press the dial to the left*	Brings up the menu./Executes the selection.
Turn the dial	Selects the menu item./Changes the setting value.

* The function varies depending on the status of this unit.

- ⑦ HDMI Input jack
- ⑧ HDMI Output jack
- ⑨ POWER jack
- ⑩ Battery compartment
- ⑪ Loudspeaker: This is a monaural Loudspeaker for checking sound.
- ⑫ Input jack AV x1
- ⑬ Headphone jack: You can connect headphones with a 3.5 mm stereo mini-plug to listen to sound.
No sound comes from the speaker when headphones are connected.



Attaching the battery and adaptor

This unit can be powered by rechargeable battery or AC adaptor. Sony battery is suitable for this unit . You cannot use other battery packs because this unit will not work.

1. Push the battery in gently in the direction shown, then slide it to the left while still pushing. There is a click as the battery is fixed into place.
2. To remove the battery Slide the battery to the right while sliding the battery release lever to the left. The battery pack comes away from this unit.

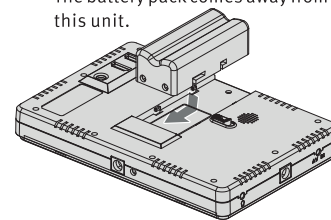
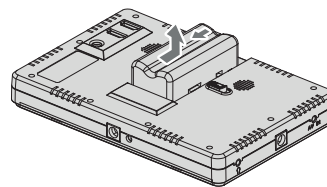

⚠ Note: Be careful not to drop the battery while removing it.

1. Select one of the provided shoe adaptors according to the shape of the accessory shoe on the camera.

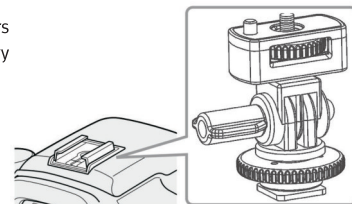

2. Insert the tripod screw of the shoe adaptor into the tripod receptacle on the bottom of this unit.
3. Turn the shoe adaptor dial to lock.

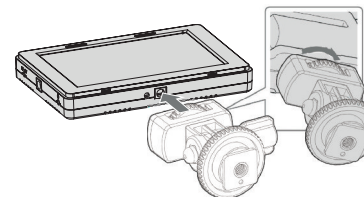

Install / Uninstall adaptor

4. If using standard shoe:

- 1 Insert the foot of the shoe adaptor fully into the standard shoe in the direction illustrated.
- 2 Rotate the dial of the shoe adaptor fully to the left to fix it firmly to the camera.

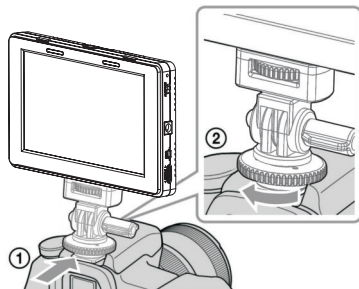

⚠ If using a camera equipped with a pop-up built-in flash, be careful of the following: Always close the built-in flash of the camera. If your camera has a built-in auto flash function, turn that function off. Before using the flash, remove this unit from the camera.

5. When using the standard shoe:

- 1 Rotate the dial of the shoe adaptor to the right to release the lock.
- 2 Check that the lock is release before sliding the shoe adaptor toward you.

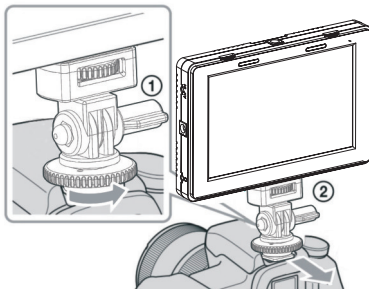

HDMI cable connection

1. Connect this unit to the camera with the HDMI cable supplied.

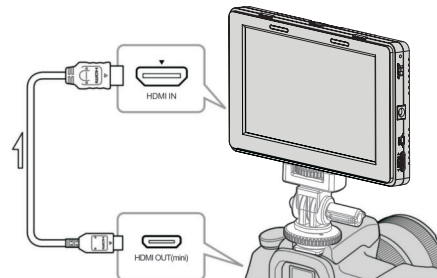

💡 Tip: If the cable is not long enough, buy a long enough HDMI cable (not supplied)

2. Turn on the power to the camera and this unit.

The viewfinder image of the camera is displayed on the LCD screen of this unit. If your camera has an HDMI output setting function, set it to AUTO or 16:9.

⚠ Note

When this unit is connected to the camera by the HDMI cable, the following may happen depending on the camera.

- No image appears on the camera's LCD screen.
- The camera switches to playback mode. (Make sure the camera is in shooting mode before taking pictures.)

💡 Tip

After a certain time in either of the following conditions, the backlight of this unit turns off.

- No HDMI signal is output from the camera.
- The HDMI cable is disconnected.

Carrying out the following turns the backlight on again.

- Press the operation dial of this unit.
- Operate the camera so that an HDMI signal is output.
- Reconnect the HDMI cable and turn the camera on.



Sun shade hood

1. Align the clips on the frame of the sun shade hood with the holes in the outer frame of this unit and attach, as illustrated.
2. To remove the sun shade hood Pull the bottom part of the sun shade hood frame towards you to remove it.

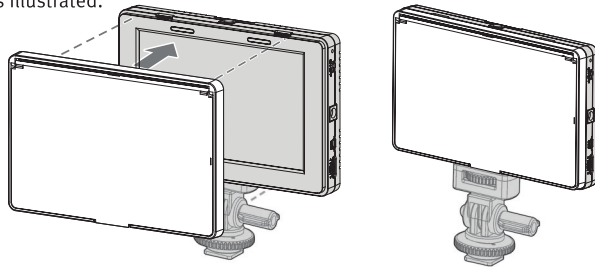

Open and close the sun shade hood as illustrated.

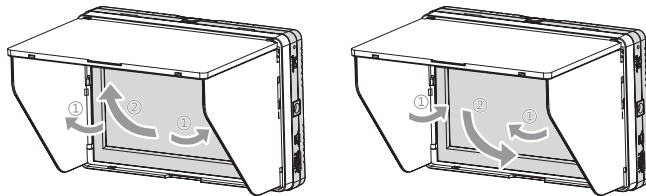

If the hood panels come away from the frame

A force applied to the top or side hood panels can detach them from the frame to prevent them from breaking. If this happens, reattach the hood panels as follows.



Adjusting the direction of the screen

The pan and tilt function of the shoe adaptor lets you move the screen of this unit in any direction.

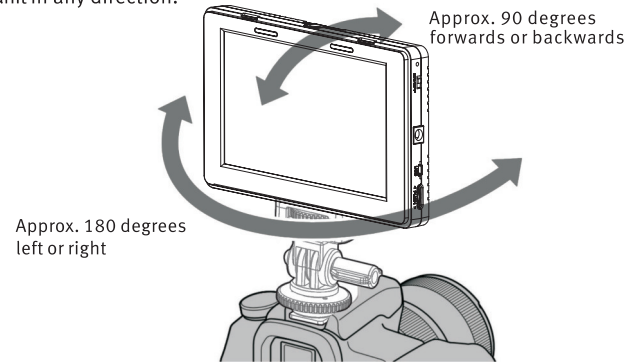

Tip

- ⦿ The moveable range of the shoe adaptor is about 90 degrees forwards or backwards and about 180 degrees left or right.

Notes

- ⦿ Depending on your battery pack and camera, this unit may interfere with the builtin flash. Do not pan or tilt with excessive force.
- ⦿ Be careful when you pull the HDMI cable not to stretch it or get it caught in any moveable part.



Menu Operation

Before changing settings, make sure device is connected with the correct signal input. Press on the DC-70II to enter the function menu. Press to choose from the main menu.

Picture	Picture Mode	User
Function	Contrast	50
Mark	Brightness	50
Input Source	Saturation	50
Menu Setting	Sharpness	50
Exit	Backlight	80
Mar 10 2016	Color Temp	User
No Signal	Picture	1/2

【Picture】

Picture Mode	User / Dynamic / Standard / Mild
Contrast	0~100 (50 by default)
Brightness	0~100 (50 by default)
Saturation	0~100 (50 by default)
Sharpness	0~100 (50 by default)
Backlight	0~100 (50 by default)
Color Temp	User / 6500K / 7200K / 9300K
Red	0~255 (128 by default)
Green	0~255 (128 by default)
Blue	0~255 (128 by default)
Return	



Menu Operation

Picture	Peaking	Off
Function	Peaking Color	Red
Mark	False Color	Off
Input Source	Exposure	Off
Menu Setting	Monochrome	Off
Exit	Aspect Ratio	Auto
Mar 10 2016	Pix to Pix	Off
No Signal	Function	2/2

【Function】

Peaking	Off / On
Peaking Color	Red / Green / Blue
False Color	Off / On
Exposure	Off / On
Monochrome	Off / Gray / Red / Green / blue
Aspect Ratio	Auto/4:3/14:9/16:10/16:9/1.85:1/2.35:1/Full
Pix to Pix	Off / On
Scan Mode	UnderScan / OverScan
Flip-H	Off / On
Flip-V	Off / On
Freeze	Off / On
Zoom	Off / 2X / 3X / 4X / 5X
Camera Mode	Off / On

Return



Menu Operation

Picture	Screen Mark	Off
Function	Center Mark	Off
Mark	Make Ratio	Off
Input Source	Make Color	White
Menu Setting	Mark Thick	1
Exit	Border trans..	On
Mar 10 2016	Return	
No Signal	Mark	1/1

【Mark】

Screen Mark	Off / 80% / 85% / 90% / 93% / 96%
Center Mark	Off / On
Make Ratio	Off / 4:3 / 2.35:1 / 1.85:1
Make Color	White / Black / Red / Green / blue
Mark Thick	1 / 2 / 3
Border transparency	Off / On

Return



Menu Operation

Picture	Input Source	HDMI
Function	Return	
Mark		
Input Source		
Menu Setting		
Exit		
Mar 10 2016		
No Signal	Input Source	1/1

【 Input Source 】

Input Source	HDMI / Video
Return	



Menu Operation

Picture	Language	English
Function	Reset	Off
Mark	Volume	50
Input Source	Transparency	Low
Menu Setting	Osd Timeout	Off
Exit	Software Upd...	Off
Mar 10 2016	Return	
No Signal	Mark	1/1

【Menu Setting】

Language	Chinese / English
Reset	Off / On
Volume	0~100 (50 by default)
Transparency	Low / Middle / High / Off
Osd Timeout	Off / 5S / 10S / 15S
Software Upgrade	Off / On

Return

Firmware upgrading method: Download the firmware to be upgraded to the root directory of USB Disk. Connect USB disk with HDMI Extra Editor through USB upgrade cable.

Select the software upgrading on the menu, press < **Menu Setting** > — < Software Upgrade > to upgrade it immediately; when the progress is up to 100%, unplug the USB disk. (In upgrading, please do not power off or take off the USB disk)



Troubleshooting

Before requesting repairs, carry out one more check. Then, if this unit still does not work properly, contact your Viltrox dealer.

Problem	Cause / Countermeasures
Cannot remove the battery	<ul style="list-style-type: none"> ⊗ The battery lock is not released. → Slide the battery release lever to the left to remove the battery.
No power to this unit	<ul style="list-style-type: none"> ⊗ The battery has run out. → Replace the battery pack. ⊗ The AC adaptor (not supplied) is disconnected. Reconnect it correctly.
Cannot attach this unit to the camera	<ul style="list-style-type: none"> ⊗ You are using the wrong type of shoe adaptor. → Check the camera shoe type and select the correct shoe adaptor.
No image appears on the screen of this unit	<ul style="list-style-type: none"> ⊗ The camera is in power save mode. → Carry out some camera function such as half-pressing the shutter button to leave power save mode. ⊗ The HDMI cable is disconnected. → Reconnect it properly. ⊗ The shooting image may not be displayed on this unit when using a camera that does not have the live view function. For details, refer to the instruction manual of your camera.
No image appears on the screen of the camera	<ul style="list-style-type: none"> ⊗ Depending on your camera, when it is connected to this unit by the HDMI cable, the image may only appear on the screen of this unit. For details, see the instruction manual of your camera.
Cannot hear sound	<ul style="list-style-type: none"> ⊗ The headphones are connected. → When the headphones are connected, no sound is output from the speaker of this unit. ⊗ Make sure the volume of this unit is not set to 0. ⊗ Make sure the sound setting of your camera is not set to OFF. ⊗ Some cameras do not output sound. ⊗ For details, check the instruction manual of your camera.
Cannot record	<ul style="list-style-type: none"> ⊗ Depending on your camera, it may switch to playback mode when connected to this unit. Switch the camera to shooting mode before taking pictures.
The screen is difficult to see	<ul style="list-style-type: none"> ⊗ Use the sun shade hood to block sunlight.
Black stripes appear on the screen	<ul style="list-style-type: none"> ⊗ The aspect ratio of the LCD panel of this unit is 15:9, so black stripes may appear depending on the image.



Specifications

LCD Display	Product Color	Black
	Screen	7 inches
	Resolution	1024×600 Pixel
Input Jack	HDMI / AV signal input	
Output Jack	HDMI signal output	
Audio	Support loudspeaker, headphone port 3.5	
Software upgrade	USB upgrade port	
Power supply	DC IN input (power port)	
Working temperature	Power Adapter	DC 8V-18V
	Battery	NP-F550/F570/F750/F770/F960
	Operating temperature	+0 to +40°C (+32 to +104°F)
	Storage temperature	-20 to +60°C (-4 to +140°F)
Dimension	191×128×21.5 mm	
Weight	480g (excluding battery)	
Accessories supplied	Hot shoe *1 Sun shade hood *1 Pouch*1 HDMI cord Type A-Type C *1 HDMI Type D (HDMI A-Micro HDMI) *1	



Available signal formats

The unit is applicable to the following signal formats:

System	Total lines	Active lines	Frame rate	Scanning	Aspect ratio
575/50I (PAL)	625	575	25	2:1 interlace	16:9 / 4:3
480/60I (NTSC)	525	483	30	2:1 interlace	16:9 / 4:3
576/50P	625	576	50	Progressive	16:9 / 4:3
480/60P	525	483	60	Progressive	16:9 / 4:3
640×480/60P	525	480	60	Progressive	4:3
1080/50I	1125	1080	25	2:1 interlace	16:9
1080/60I	1125	1080	30	2:1 interlace	16:9
720/50P	750	720	50	Progressive	16:9
720/60P	750	720	60	Progressive	16:9
1080/50P	1125	1080	50	Progressive	16:9
1080/60P	1125	1080	60	Progressive	16:9

Product specifications and external appearance are subject to change without notice.